

1. számú melléklet

EuroFox homlokzatburkolat rögzítő rendszer termékei

A melléklet 21 oldalt tartalmaz.

01 Distanzhalter | brackets

01.1 FOX + Isolator (FIX in a FOX) SMALL 60

Werkstoff | material: EN AW-6063 T66, Festpunkt/Gleitpunkt | fixpoint/flexible point
Isolator | insulation pad: Material | material: polypropylen



V	Artikelnummer Order number
	01 FOI 120 S 11
120	01 FOI 120 S 6,5
	01 FOI 120 S 15
	01 FOI 140 S 11
140	01 FOI 140 S 6,5
	01 FOI 140 S 15
	01 FOI 160 S 11
160	01 FOI 160 S 6,5
	01 FOI 160 S 15
	01 FOI 180 S 11
180	01 FOI 180 S 6,5
	01 FOI 180 S 15
	01 FOI 200 S 11
200	01 FOI 200 S 6,5
	01 FOI 200 S 15

V	Artikelnummer Order number
	01 FOI 220 S 11
220	01 FOI 220 S 6,5
	01 FOI 220 S 15
	01 FOI 240 S 11
240	01 FOI 240 S 6,5
	01 FOI 240 S 15
	01 FOI 260 S 11
260	01 FOI 260 S 6,5
	01 FOI 260 S 15
	01 FOI 280 S 11
280	01 FOI 280 S 6,5
	01 FOI 280 S 15

FOX SMALL + Isolator
Lochbilder/hoie pattern

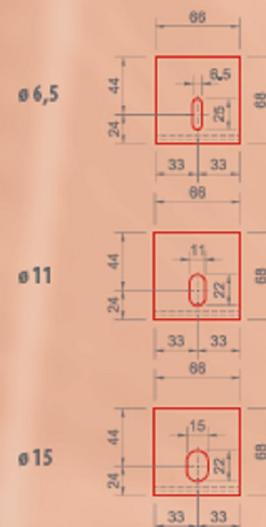

01 Distanzhalter | brackets

01.1 FOX (FIX in a FOX) SMALL 60

Werkstoff | material: EN AW-6063 T66 • Festpunkt/Gleitpunkt | fixpoint/flexible point



FOX SMALL
Lochbilder/hole pattern

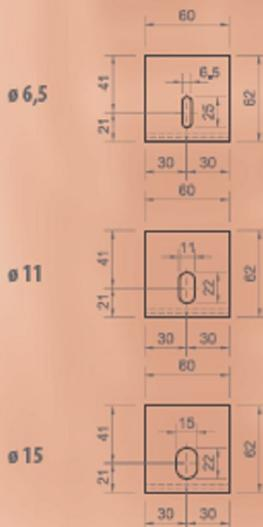

V	Artikelnummer Order number
	01 F0 115 S 11
115	01 F0 115 S 6,5
	01 F0 115 S 15
	01 F0 135 S 11
135	01 F0 135 S 6,5
	01 F0 135 S 15
	01 F0 155 S 11
155	01 F0 155 S 6,5
	01 F0 155 S 15
	01 F0 175 S 11
175	01 F0 175 S 6,5
	01 F0 175 S 15
	01 F0 195 S 11
195	01 F0 195 S 6,5
	01 F0 195 S 15

V	Artikelnummer Order number
	01 F0 215 S 11
215	01 F0 215 S 6,5
	01 F0 215 S 15
	01 F0 235 S 11
235	01 F0 235 S 6,5
	01 F0 235 S 15
	01 F0 255 S 11
255	01 F0 255 S 6,5
	01 F0 255 S 15
	01 F0 275 S 11
275	01 F0 275 S 6,5
	01 F0 275 S 15



01 Distanzhalter | brackets

01.1 FOX + Isolator (FIX in a FOX) MEDIUM 80

Werkstoff | material: EN AW-6063 T66 - Festpunkt/Gleitpunkt | fix point/slidable point
Isolator | insulation pad: Material | material: polypropylen

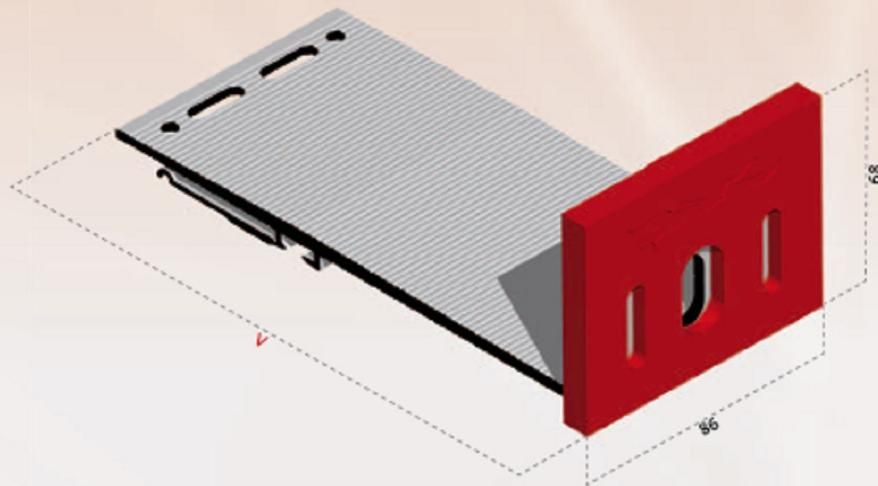

V	Artikelnummer Order number
	01 FOI 120 M11
120	01 FOI 120 M 6,5
	01 FOI 120 M 15
	01 FOI 140 M 11
140	01 FOI 140 M 6,5
	01 FOI 140 M 15
	01 FOI 160 M 11
160	01 FOI 160 M 6,5
	01 FOI 160 M 15
	01 FOI 180 M 11
180	01 FOI 180 M 6,5
	01 FOI 180 M 15
	01 FOI 200 M 11
200	01 FOI 200 M 6,5
	01 FOI 200 M 15

V	Artikelnummer Order number
	01 FOI 220 M 11
220	01 FOI 220 M 6,5
	01 FOI 220 M 15
	01 FOI 240 M 11
240	01 FOI 240 M 6,5
	01 FOI 240 M 15
	01 FOI 260 M 11
260	01 FOI 260 M 6,5
	01 FOI 260 M 15
	01 FOI 280 M 11
280	01 FOI 280 M 6,5
	01 FOI 280 M 15

FOX MEDIUM + Isolator
Lochbilder/hole pattern

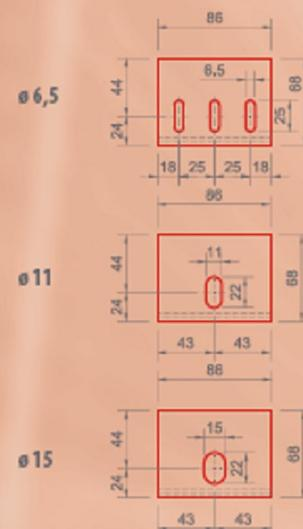

01 Distanzhalter | brackets

01.1 FOX (FIX in a FOX) MEDIUM 80

Werkstoff | material: EN AW-6063 T66 • Festpunkt/Gleitpunkt | fix point/slidable point

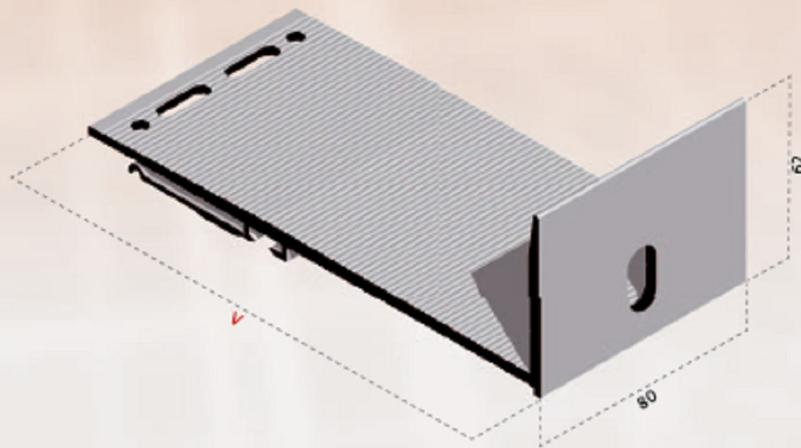

FOX MEDIUM
Lochbilder/hole pattern

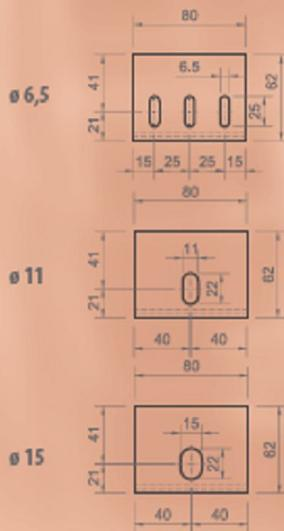

V	Artikelnummer Order number
	01 F0 115 M 11
115	01 F0 115 M 6,5
	01 F0 115 M 15
	01 F0 135 M 11
135	01 F0 135 M 6,5
	01 F0 135 M 15
	01 F0 155 M 11
155	01 F0 155 M 6,5
	01 F0 155 M 15
	01 F0 175 M 11
175	01 F0 175 M 6,5
	01 F0 175 M 15
	01 F0 195 M 11
195	01 F0 195 M 6,5
	01 F0 195 M 15

V	Artikelnummer Order number
	01 F0 215 M 11
215	01 F0 215 M 6,5
	01 F0 215 M 15
	01 F0 235 M 11
235	01 F0 235 M 6,5
	01 F0 235 M 15
	01 F0 255 M 11
255	01 F0 255 M 6,5
	01 F0 255 M 15
	01 F0 275 M 11
275	01 F0 275 M 6,5
	01 F0 275 M 15



01 Distanzhalter | brackets

01.1 FOX + Isolator (FIX in a FOX) LARGE 160

Werkstoff | material: EN AW-6063 T66, Festpunkt/Gleitpunkt | fixpoint/flexible point
Isolator | insulation pad: Material | material: polypropylen

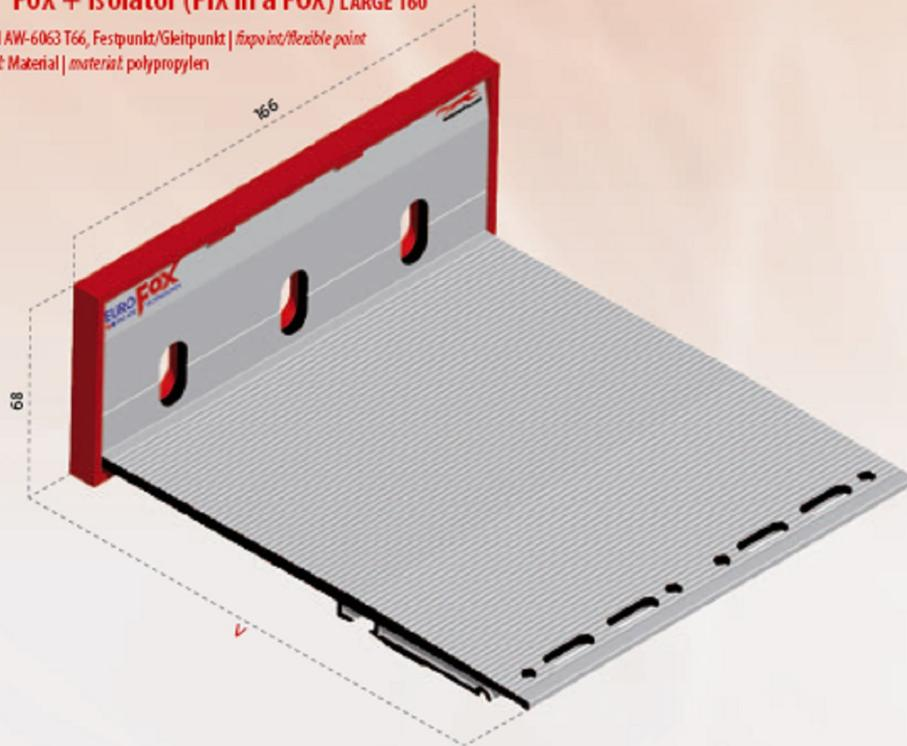

V	Artikelnummer Order number
	01 FOI 120 L 11
120	01 FOI 120 L 6,5
	01 FOI 120 L 15
	01 FOI 140 L 11
140	01 FOI 140 L 6,5
	01 FOI 140 L 15
	01 FOI 160 L 11
160	01 FOI 160 L 6,5
	01 FOI 160 L 15
	01 FOI 180 L 11
180	01 FOI 180 L 6,5
	01 FOI 180 L 15
	01 FOI 200 L 11
200	01 FOI 200 L 6,5
	01 FOI 200 L 15

V	Artikelnummer Order number
	01 FOI 220 L 11
220	01 FOI 220 L 6,5
	01 FOI 220 L 15
	01 FOI 240 L 11
240	01 FOI 240 L 6,5
	01 FOI 240 L 15
	01 FOI 260 L 11
260	01 FOI 260 L 6,5
	01 FOI 260 L 15
	01 FOI 280 L 11
280	01 FOI 280 L 6,5
	01 FOI 280 L 15

FOX LARGE + Isolator
Lochbilder/hole pattern

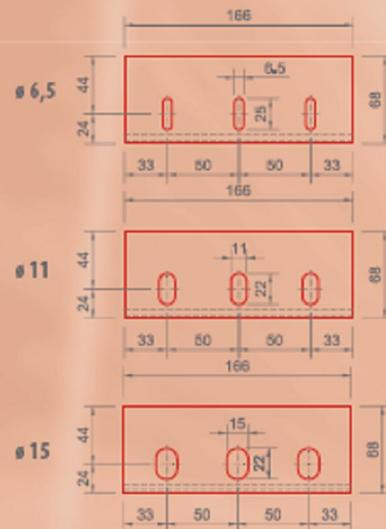

01 Distanzhalter | brackets

01.1 FOX (FIX in a FOX) LARGE 160

Werkstoff | material: EN AW-6063 T66 • Festpunkt/Gleitpunkt | fix point/slidable point

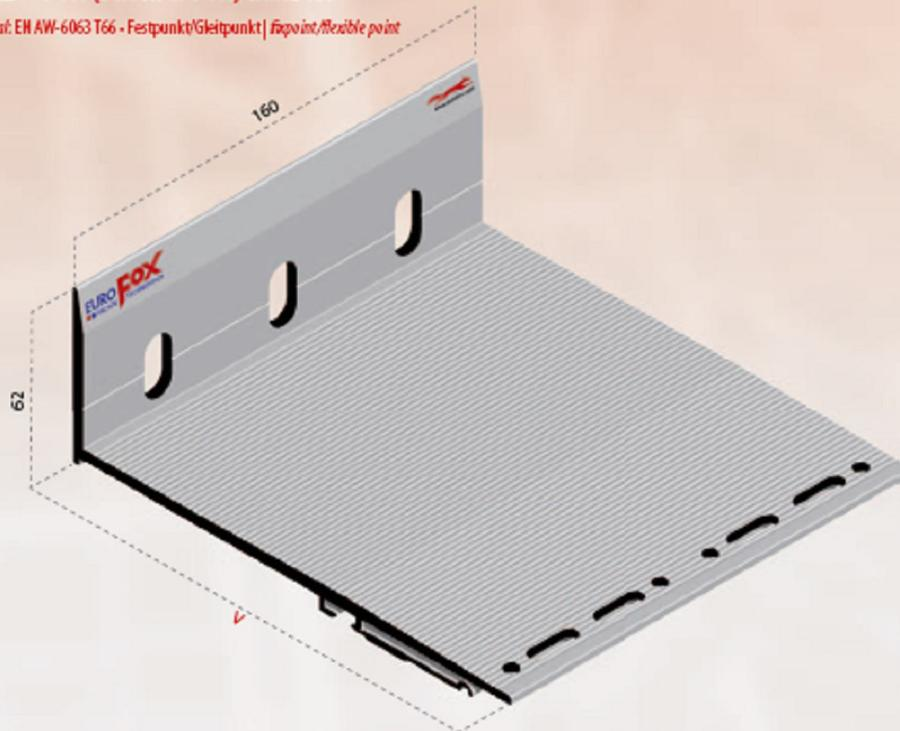

FOX LARGE
Lochbilder/hole pattern

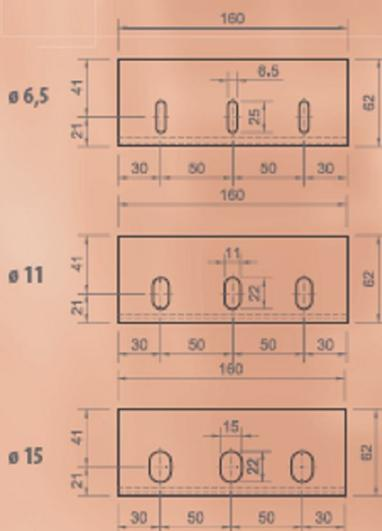

V	Artikelnummer Order number
	01 F0 115 L 11
115	01 F0 115 L 6,5
	01 F0 115 L 15
	01 F0 135 L 11
135	01 F0 135 L 6,5
	01 F0 135 L 15
	01 F0 155 L 11
155	01 F0 155 L 6,5
	01 F0 155 L 15
	01 F0 175 L 11
175	01 F0 175 L 6,5
	01 F0 175 L 15
	01 F0 195 L 11
195	01 F0 195 L 6,5
	01 F0 195 L 15

V	Artikelnummer Order number
	01 F0 215 L 11
215	01 F0 215 L 6,5
	01 F0 215 L 15
	01 F0 235 L 11
235	01 F0 235 L 6,5
	01 F0 235 L 15
	01 F0 255 L 11
255	01 F0 255 L 6,5
	01 F0 255 L 15
	01 F0 275 L 11
275	01 F0 275 L 6,5
	01 F0 275 L 15



01 Distanzhalter | brackets

01.1 FIX + Isolator (FIX in a FOX) SMALL 60

Werkstoff | material: EN AW-6063 T66, Festpunkt/Gleitpunkt | fixpoint/flexible point
Isolator | insulation pad: Material | material: polypropylen

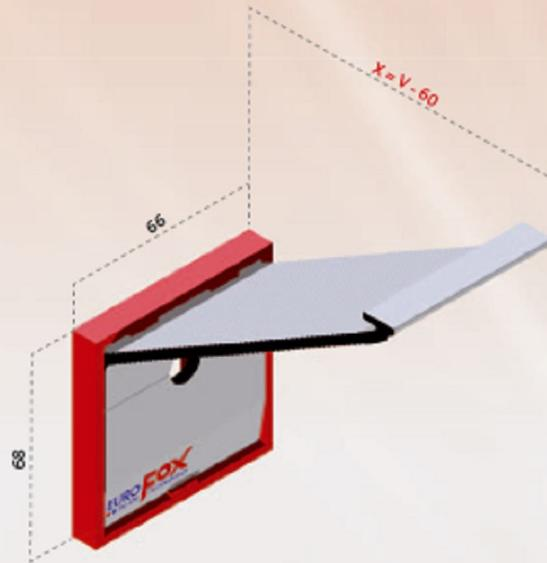

V	Artikelnummer Order number
	01 FII 120 S 11
120	01 FII 120 S 6,5
	01 FII 120 S 15
	01 FII 140 S 11
140	01 FII 140 S 6,5
	01 FII 140 S 15
	01 FII 160 S 11
160	01 FII 160 S 6,5
	01 FII 160 S 15
	01 FII 180 S 11
180	01 FII 180 S 6,5
	01 FII 180 S 15
	01 FII 200 S 11
200	01 FII 200 S 6,5
	01 FII 200 S 15

V	Artikelnummer Order number
	01 FII 220 S 11
220	01 FII 220 S 6,5
	01 FII 220 S 15
	01 FII 240 S 11
240	01 FII 240 S 6,5
	01 FII 240 S 15
	01 FII 260 S 11
260	01 FII 260 S 6,5
	01 FII 260 S 15
	01 FII 280 S 11
280	01 FII 280 S 6,5
	01 FII 280 S 15

FIX SMALL + Isolator
Lochbilder/hole pattern



01 Distanzhalter | brackets

01.1 FIX (FIX in a FOX) SMALL 60

Werkstoff | material: EN AW-6063 T66, Festpunkt/Gleitpunkt | fixpoint/flexible point

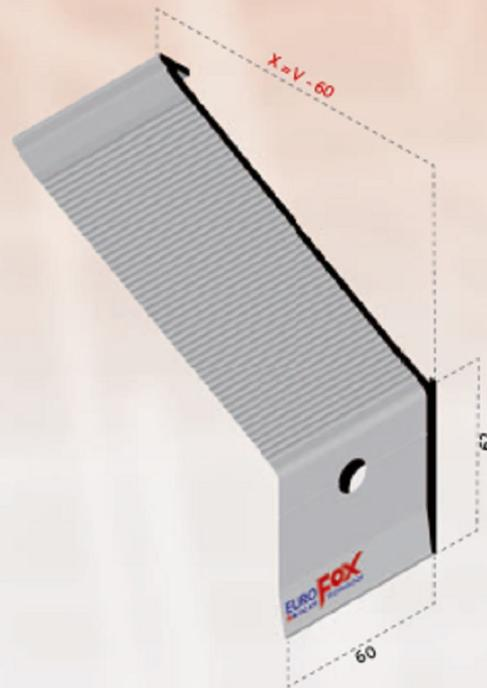

FIX SMALL
Lochbilder/hole pattern

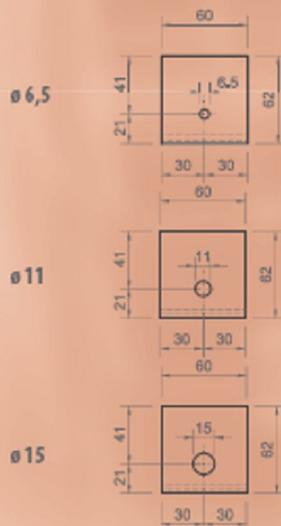

V	Artikelnummer Order number
	01 FI 115 S 11
115	01 FI 115 S 6,5
	01 FI 115 S 15
	01 FI 135 S 11
135	01 FI 135 S 6,5
	01 FI 135 S 15
	01 FI 155 S 11
155	01 FI 155 S 6,5
	01 FI 155 S 15
	01 FI 175 S 11
175	01 FI 175 S 6,5
	01 FI 175 S 15
	01 FI 195 S 11
195	01 FI 195 S 6,5
	01 FI 195 S 15

V	Artikelnummer Order number
	01 FI 215 S 11
215	01 FI 215 S 6,5
	01 FI 215 S 15
	01 FI 235 S 11
235	01 FI 235 S 6,5
	01 FI 235 S 15
	01 FI 255 S 11
255	01 FI 255 S 6,5
	01 FI 255 S 15
	01 FI 275 S 11
275	01 FI 275 S 6,5
	01 FI 275 S 15



01 Distanzhalter | brackets

01.2 MacFOX + Isolator MEDIUM 80

Werkstoff | material: EN AW-6063 T66 - Festpunkt/Gleitpunkt | fix point/slidable point
Isolator / insulation pad: polypropylen

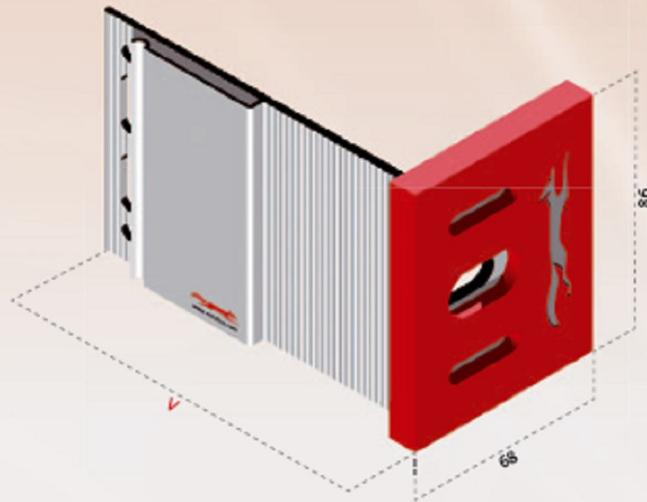

V	Artikelnummer Order number
	01 MFI 065 M 11
65	01 MFI 065 M 6,5 S
	01 MFI 065 M 15
	01 MFI 095 M 11
95	01 MFI 095 M 6,5 S
	01 MFI 095 M 15
	01 MFI 125 M 11
125	01 MFI 125 M 6,5 S
	01 MFI 125 M 15
	01 MFI 155 M 11
155	01 MFI 155 M 6,5 S
	01 MFI 155 M 15

V	Artikelnummer Order number
	01 MFI 185 M 11
185	01 MFI 185 M 6,5 S
	01 MFI 185 M 15
	01 MFI 215 M 11
215	01 MFI 215 M 6,5 S
	01 MFI 215 M 15
	01 MFI 245 M 11
245	01 MFI 245 M 6,5 S
	01 MFI 245 M 15
	01 MFI 275 M 11
275	01 MFI 275 M 6,5 S
	01 MFI 275 M 15

MacFOX MEDIUM + Isolator
Lochbilder/hole pattern

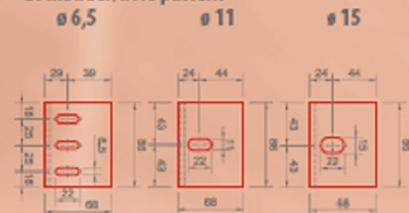

01 Distanzhalter | brackets

01.2 MacFOX MEDIUM 80

Werkstoff | material: EN AW-6063 T66 • Festpunkt/Gleitpunkt | fix point/flexible point

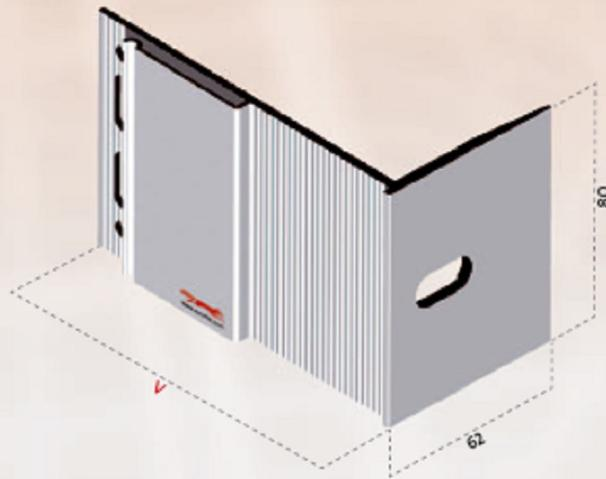

V	Artikelnummer Order number
	01 MF 040 M 11
40	01 MF 040 M 6,5 S
	01 MF 040 M 15
	01 MF 060 M 11
60	01 MF 060 M 6,5 S
	01 MF 060 M 15
	01 MF 90 M 11
90	01 MF 90 M 6,5 S
	01 MF 90 M 15
	01 MF 120 M 11
120	01 MF 120 M 6,5 S
	01 MF 120 M 15

V	Artikelnummer Order number
	01 MF 150 M 11
150	01 MF 150 M 6,5 S
	01 MF 150 M 15
	01 MF 180 M 11
180	01 MF 180 M 6,5 S
	01 MF 180 M 15
	01 MF 210 M 11
210	01 MF 210 M 6,5 S
	01 MF 210 M 15
	01 MF 240 M 11
240	01 MF 240 M 6,5 S
	01 MF 270 M 15

V	Artikelnummer Order number
	01 MF 270 M 11
270	01 MF 270 M 6,5 S
	01 MF 270 M 15

MacFOX MEDIUM
Lochbilder/hole pattern

ø 6,5 ø 11 ø 15

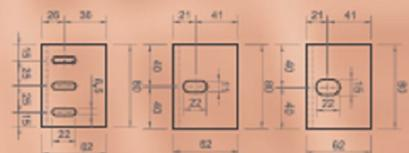

01 Distanzhalter | brackets

01.2 MacFOX + Isolator LARGE 160

Werkstoff | material: EN AW-6063 T66 - Festpunkt/Gleitpunkt | fix point/slidable point
Isolator / insulation pad: polypropylen

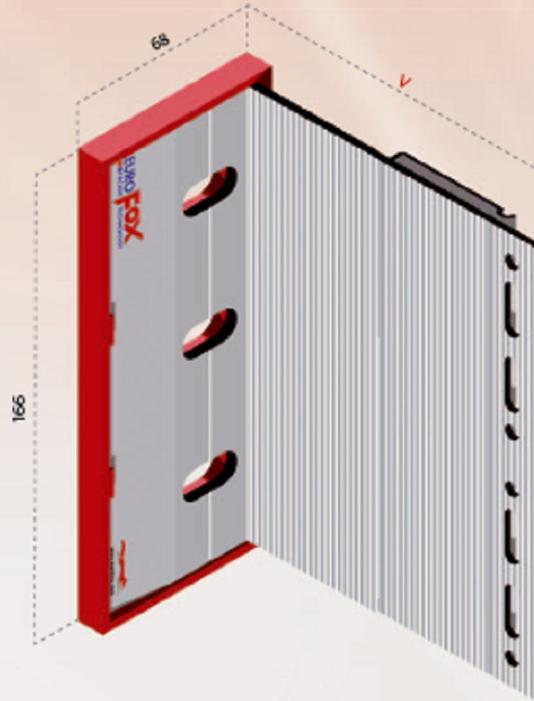

V	Artikelnummer Order number
	01 MFI 065 L 11
65	01 MFI 065 L 6,5S
	01 MFI 065 L 15
	01 MFI 095 L 11
95	01 MFI 095 L 6,5S
	01 MFI 095 L 15
	01 MFI 125 L 11
125	01 MFI 125 L 6,5S
	01 MFI 125 L 15
	01 MFI 155 L 11
155	01 MFI 155 L 6,5S
	01 MFI 155 L 15

V	Artikelnummer Order number
	01 MFI 185 L 11
185	01 MFI 185 L 6,5S
	01 MFI 185 L 15
	01 MFI 215 L 11
215	01 MFI 215 L 6,5S
	01 MFI 215 L 15
	01 MFI 245 L 11
245	01 MFI 245 L 6,5S
	01 MFI 245 L 15
	01 MFI 275 L 11
275	01 MFI 275 L 6,5S
	01 MFI 275 L 15

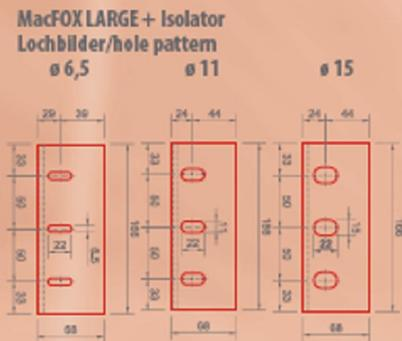

01 Distanzhalter | brackets

01.2 MacFOX LARGE 160

Werkstoff | matériel: EN AW-6063 T66 • Festpunkt/Gleitpunkt | fixe point/flexible point

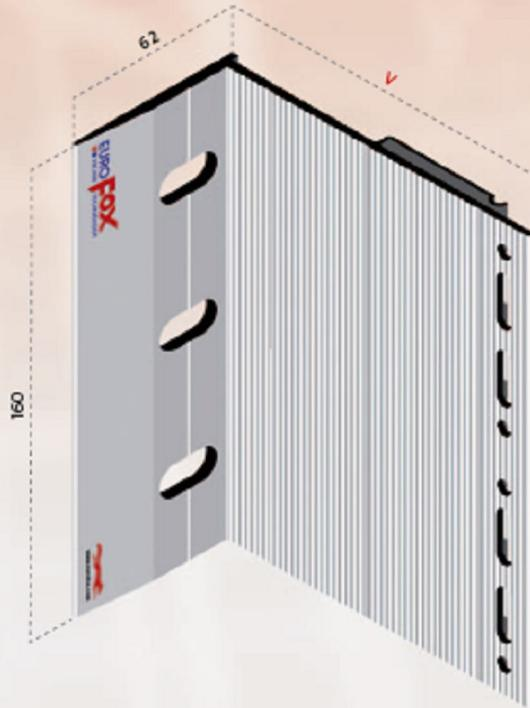

V	Artikelnummer Order number
	01 MF 040 L 11
40	01 MF 040 L 6,5 S
	01 MF 040 L 15
	01 MF 060 L 11
60	01 MF 060 L 6,5 S
	01 MF 060 L 15
	01 MF 90 L 11
90	01 MF 90 L 6,5 S
	01 MF 90 L 15
	01 MF 120 L 11
120	01 MF 120 L 6,5 S
	01 MF 120 L 15

V	Artikelnummer Order number
	01 MF 150 L 11
150	01 MF 150 L 6,5 S
	01 MF 150 L 15
	01 MF 180 L 11
180	01 MF 180 L 6,5 S
	01 MF 180 L 15
	01 MF 210 L 11
210	01 MF 210 L 6,5 S
	01 MF 210 L 15
	01 MF 240 L 11
240	01 MF 240 L 6,5 S
	01 MF 270 L 15

V	Artikelnummer Order number
	01 MF 270 L 11
270	01 MF 270 L 6,5 S
	01 MF 270 L 15

MacFOX LARGE Lochbilder/hole pattern
ø 6,5 ø 11 ø 15

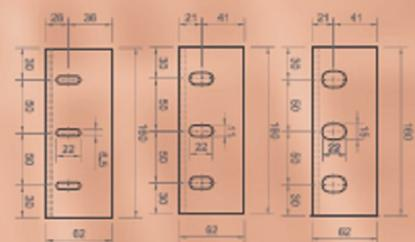

01 Distanzhalter | brackets

01.3 ECOFOX UNO

Werkstoff | material: EN AW-5754, Festpunkt/Gleitpunkt | fixpoint/movable point •
Isolator | insulation pad: Material | material: polypropylen

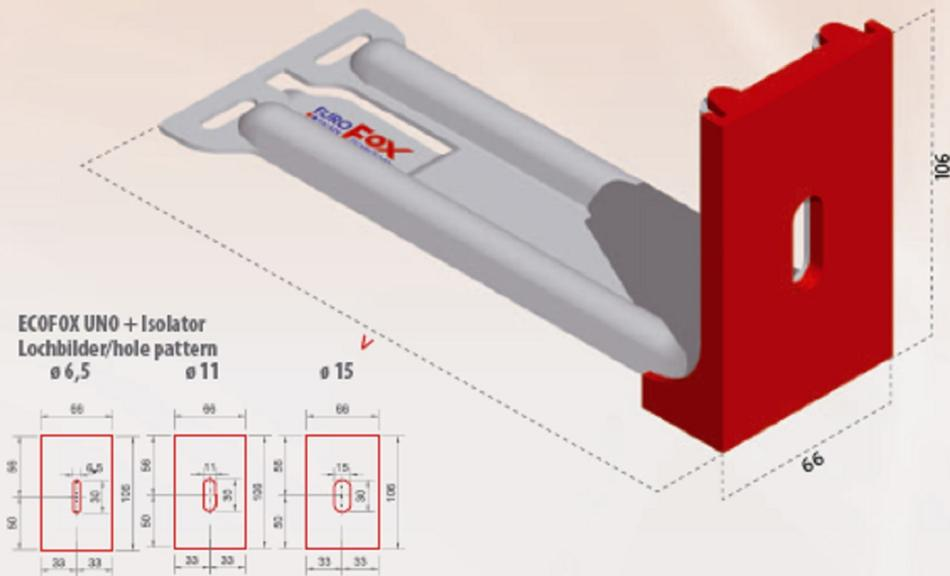

V	Artikelnummer Order number
	01 EFI 140 UNO 11
140	01 EFI 140 UNO 6,5
	01 EFI 140 UNO 15
	01 EFI 160 UNO 11
160	01 EFI 160 UNO 6,5
	01 EFI 160 UNO 15
	01 EFI 180 UNO 11
180	01 EFI 180 UNO 6,5
	01 EFI 180 UNO 15
	01 EFI 200 UNO 11
200	01 EFI 200 UNO 6,5
	01 EFI 200 UNO 15

V	Artikelnummer Order number
	01 EFI 220 UNO 11
220	01 EFI 220 UNO 6,5
	01 EFI 220 UNO 15
	01 EFI 240 UNO 11
240	01 EFI 240 UNO 6,5
	01 EFI 240 UNO 15
	01 EFI 260 UNO 11
260	01 EFI 260 UNO 6,5
	01 EFI 260 UNO 15
	01 EFI 280 UNO 11
280	01 EFI 280 UNO 6,5
	01 EFI 360 UNO 15

V	Artikelnummer Order number
	01 EFI 300 UNO 11
300	01 EFI 300 UNO 6,5
	01 EFI 300 UNO 15
	01 EFI 320 UNO 11
320	01 EFI 320 UNO 6,5
	01 EFI 320 UNO 15
	01 EFI 340 UNO 11
340	01 EFI 340 UNO 6,5
	01 EFI 340 UNO 15
	01 EFI 360 UNO 11
360	01 EFI 360 UNO 6,5
	01 EFI 360 UNO 15

01 Distanzhalter | brackets

01.3 ECOFOX UNO

Werkstoff | material: EN 99-5754, Festpunkt/Gleitpunkt | fix point/flexible point
Isolator | insulation pad: Material | material: polypropylen



ECOFOX UNO + Isolator
Lochbilder/hole pattern
ø 6,5 ø 11 ø 15

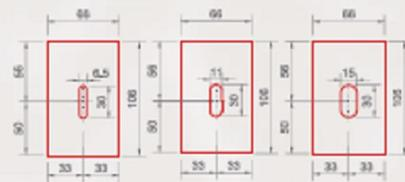

V	Artikelnummer Order number
	01 EFI 380 UNO 11
380	01 EFI 380 UNO 6,5
	01 EFI 380 UNO 15
	01 EFI 400 UNO 11
400	01 EFI 400 UNO 6,5
	01 EFI 400 UNO 15
	01 EFI 420 UNO 11
420	01 EFI 420 UNO 6,5
	01 EFI 420 UNO 15
	01 EFI 440 UNO 11
440	01 EFI 440 UNO 6,5
	01 EFI 440 UNO 15

V	Artikelnummer Order number
	01 EFI 460 UNO 11
460	01 EFI 460 UNO 6,5
	01 EFI 460 UNO 15
	01 EFI 480 UNO 11
480	01 EFI 480 UNO 6,5
	01 EFI 480 UNO 15
	01 EFI 500 UNO 11
500	01 EFI 500 UNO 6,5
	01 EFI 500 UNO 15
	01 EFI 520 UNO 11
520	01 EFI 520 UNO 6,5
	01 EFI 520 UNO 15

V	Artikelnummer Order number
	01 EFI 540 UNO 11
540	01 EFI 540 UNO 6,5
	01 EFI 540 UNO 15
	01 EFI 560 UNO 11
560	01 EFI 560 UNO 6,5
	01 EFI 560 UNO 15
	01 EFI 580 UNO 11
580	01 EFI 580 UNO 6,5
	01 EFI 580 UNO 15
	01 EFI 600 UNO 11
600	01 EFI 600 UNO 6,5
	01 EFI 600 UNO 15



01 Distanzhalter | brackets

01.3 ECOFOX DUO

Werkstoff | material: EN AW-5754, Festpunkt/Gleitpunkt | fixpoint/flexible point
Isolator | insulation pad: Material | material: polypropylen

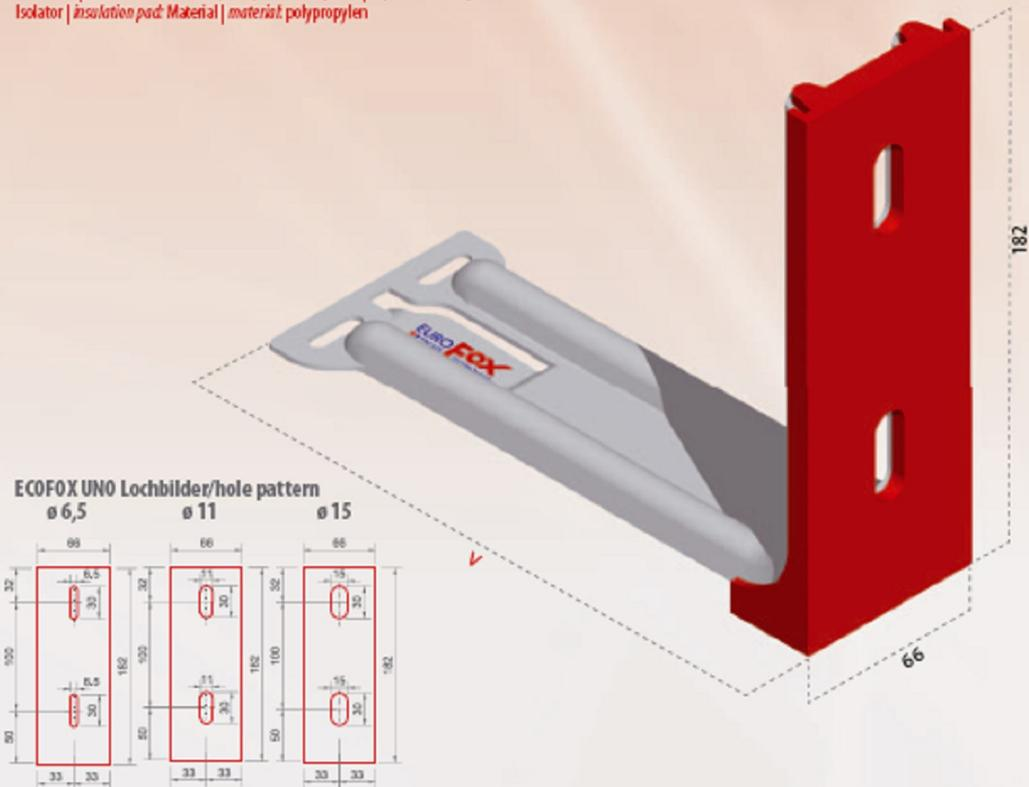

V	Artikelnummer Order number
	01 EFI 140 DU0 11
140	01 EFI 140 DU0 6,5
	01 EFI 140 DU0 15
	01 EFI 160 DU0 11
160	01 EFI 160 DU0 6,5
	01 EFI 160 DU0 15
	01 EFI 180 DU0 11
180	01 EFI 180 DU0 6,5
	01 EFI 180 DU0 15
	01 EFI 200 DU0 11
200	01 EFI 200 DU0 6,5
	01 EFI 200 DU0 15

V	Artikelnummer Order number
	01 EFI 220 DU0 11
220	01 EFI 220 DU0 6,5
	01 EFI 220 DU0 15
	01 EFI 240 DU0 11
240	01 EFI 240 DU0 6,5
	01 EFI 240 DU0 15
	01 EFI 260 DU0 11
260	01 EFI 260 DU0 6,5
	01 EFI 260 DU0 15
	01 EFI 280 DU0 11
280	01 EFI 280 DU0 6,5
	01 EFI 280 DU0 15

V	Artikelnummer Order number
	01 EFI 300 DU0 11
300	01 EFI 300 DU0 6,5
	01 EFI 300 DU0 15
	01 EFI 320 DU0 11
320	01 EFI 320 DU0 6,5
	01 EFI 320 DU0 15
	01 EFI 340 DU0 11
340	01 EFI 340 DU0 6,5
	01 EFI 340 DU0 15
	01 EFI 360 DU0 11
360	01 EFI 360 DU0 6,5
	01 EFI 360 DU0 15

01 Distanzhalter | brackets

01.3 ECOFOX DUO

Werkstoff | material: EN AW-5754, Festpunkt/Gleitpunkt | fixpoint/flexible point
Isolator | insulation pad | Material | material: polypropylen



ECOFOX UNO Lochbilder/hole pattern
ø 6,5 ø 11 ø 15

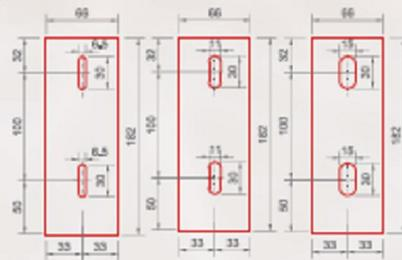

V	Artikelnummer Order number
	01 EFI 380 DUO 11
380	01 EFI 380 DUO 6,5
	01 EFI 380 DUO 15
	01 EFI 400 DUO 11
400	01 EFI 400 DUO 6,5
	01 EFI 400 DUO 15
	01 EFI 420 DUO 11
420	01 EFI 420 DUO 6,5
	01 EFI 420 DUO 15
	01 EFI 440 DUO 11
440	01 EFI 440 DUO 6,5
	01 EFI 440 DUO 15

V	Artikelnummer Order number
	01 EFI 460 DUO 11
460	01 EFI 460 DUO 6,5
	01 EFI 460 DUO 15
	01 EFI 480 DUO 11
480	01 EFI 480 DUO 6,5
	01 EFI 480 DUO 15
	01 EFI 500 DUO 11
500	01 EFI 500 DUO 6,5
	01 EFI 500 DUO 15
	01 EFI 520 DUO 11
520	01 EFI 520 DUO 6,5
	01 EFI 520 DUO 15

V	Artikelnummer Order number
	01 EFI 540 DUO 11
540	01 EFI 540 DUO 6,5
	01 EFI 540 DUO 15
	01 EFI 560 DUO 11
560	01 EFI 560 DUO 6,5
	01 EFI 560 DUO 15
	01 EFI 580 DUO 11
580	01 EFI 580 DUO 6,5
	01 EFI 580 DUO 15
	01 EFI 600 DUO 11
600	01 EFI 600 DUO 6,5
	01 EFI 600 DUO 15



01 Distanzhalter | brackets

01.4 XFOX MEDIUM 80

Werkstoff | material: EN AW-6060 T66 • Festpunkt/Gleitpunkt | fix point/flexible point

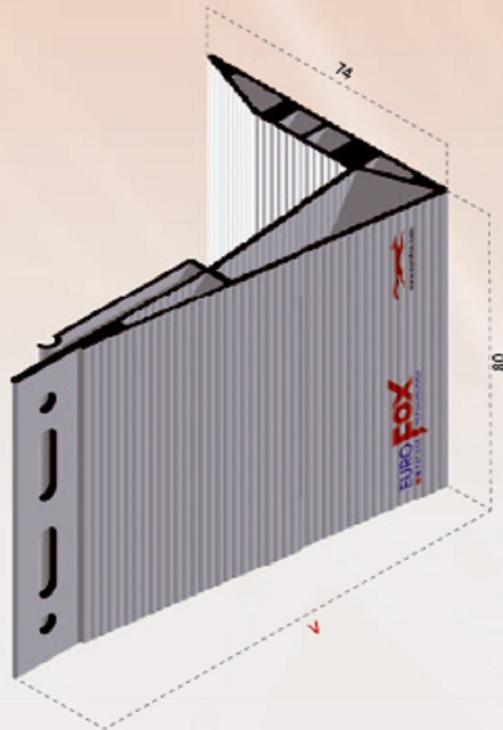

V	Artikelnummer Order number
70	01 XF 070 M 11
	01 XF 070 M 6,5 /2
90	01 XF 090 M 11
	01 XF 090 M 6,5 /2
120	01 XF 120 M 11
	01 XF 120 M 6,5 /2
150	01 XF 150 M 11
	01 XF 150 M 6,5 /2
180	01 XF 180 M 11
	01 XF 180 M 6,5 /2

XFOX MEDIUM Lochbilder/hole pattern
ø 6,5 ø 11

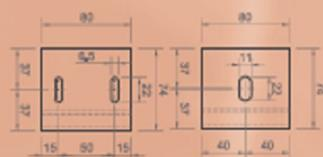

01 Distanzhalter | brackets

01.4 XFOX LARGE 160

Werkstoff | material: EN AW-6060 T66 • Festpunkt/Gleitpunkt | fixpoint/flexible point

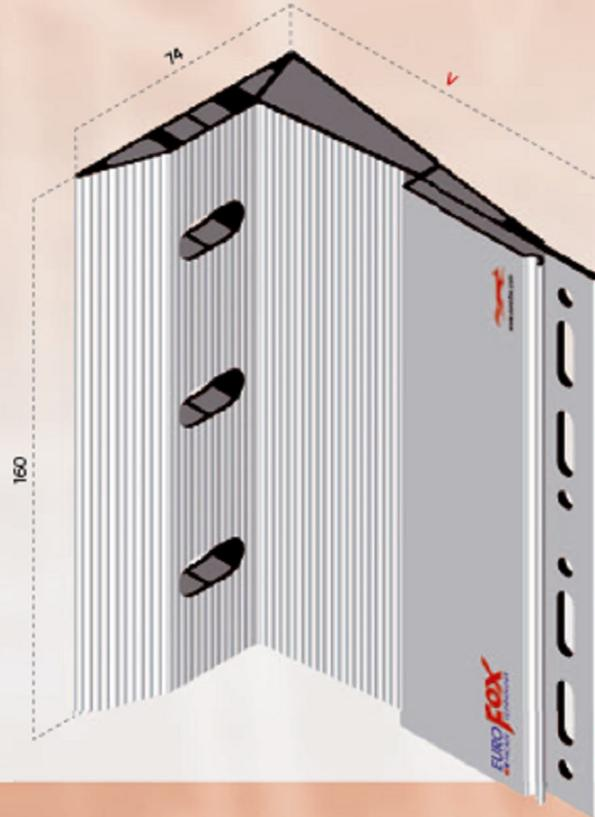

XFOX LARGE Lochbilder/hole pattern
ø 6,5 ø 11

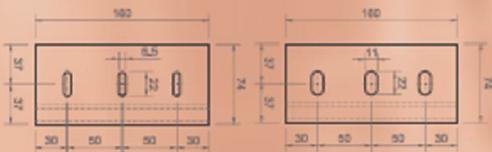

V	Artikelnummer Order number
70	01XF 070 L 11
	01XF 070 L 6,5
90	01XF 090 L 11
	01XF 090 L 6,5
120	01XF 120 L 11
	01XF 120 L 6,5
150	01XF 150 L 11
	01XF 150 L 6,5
180	01XF 180 L 11
	01XF 180 L 6,5



03 Zubehör für Distanzhalter | accessories for brackets

03.1

UNI

Werkstoff | material: EN AW-6063 T66

Für Holzlatten und Hohlprofile | for timber battens

LARGE 160

W	H	Artikelnummer Order number
50	160	03 UNI 050 L
60	160	03 UNI 060 L
80	160	03 UNI 080 L
100	160	03 UNI 100 L

LARGE 160

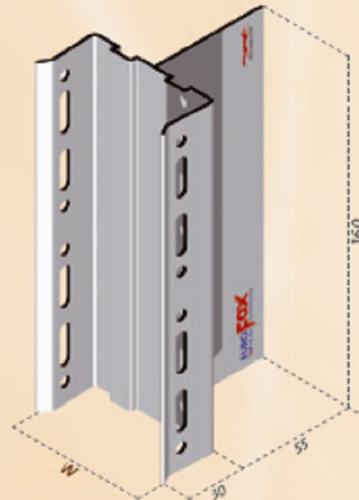

MEDIUM 80

W	H	Artikelnummer Order number
50	80	03 UNI 050 M
60	80	03 UNI 060 M
80	80	03 UNI 080 M
100	80	03 UNI 100 M

MEDIUM 80

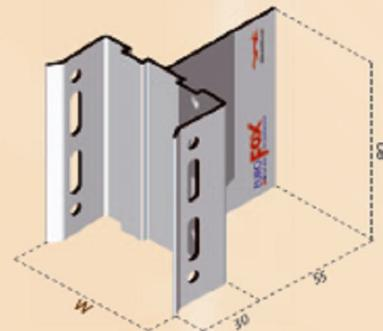

03 Zubehör für Distanzhalter | accessories for brackets

03.2

DISFOX

Werkstoff | material: EN AW-6063 T66
Distanzstück | distance-element

Artikelnummer Order number
03 DF M
03 DF L

LARGE 160

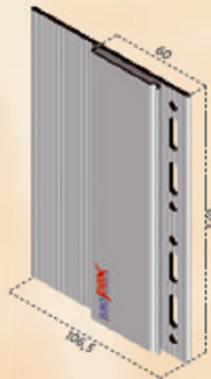

MEDIUM 80

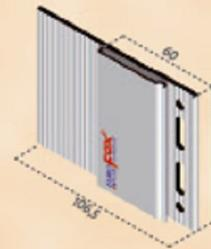

03.3

CONFOX

Werkstoff | material: EN AW-6063 T66
Verbindungsstück | connection-element

Artikelnummer Order number
03 CON



03.4

CeilingFOX

Werkstoff | material: EN AW-6063 T66
Sonderkonsole für Deckenabhängung | special
T-profile for ceiling

V	Artikelnummer Order number
300	03 CF 0300
500	03 CF 0500
1000	03 CF 1000

Länge | length:
0 - 300
300 - 500
500 - 1000



04 Standard Profile | standard profiles

04.1

L-Profile(s)

Werkstoff | material: EN AW-6063 T66
Länge | length: 6.000 mm

Artikelnummer Order number
04 L 40x40 1,8 E
04 L 60x40 1,8 E
04 L 60x40 1,8 E K
04 L 60x40 2,0 E
04 L 60x40 2,0 E K



04.2

T-Profile(s)

Werkstoff | material: EN AW-6063 T66
Länge | length: 6.000 mm

V	Artikelnummer Order number
80	04 T 40x80 1,8
80	04 T 60x80 1,8 E
100	04 T 60x100 1,8 E
100	04 T 60x100 1,8 E K*
100	04 T 60x100 2,0
100	04 T 60x100 2,2
120	04 T 60x120 1,8 E
120	04 T 60x120 1,8 E K*
120	04 T 60x120 2,0
140	04 T 60x140 2,0 E
140	04 T 60x140 2,2

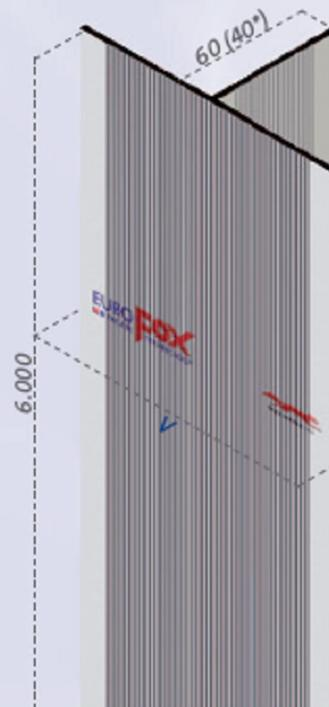

* Profile speziell für
Klebertechnik |
profile special for gluing